

8-Achs Plateauhänger
 techn. Nutzlast: 160.000 kg

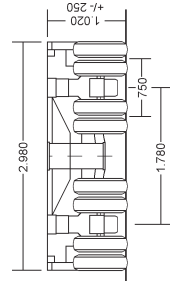

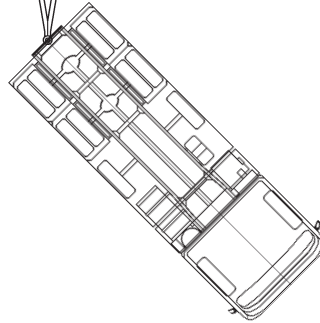

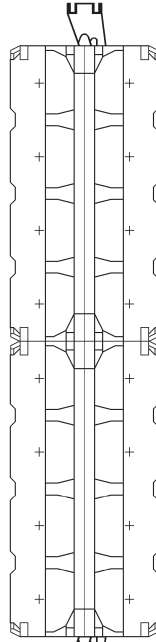
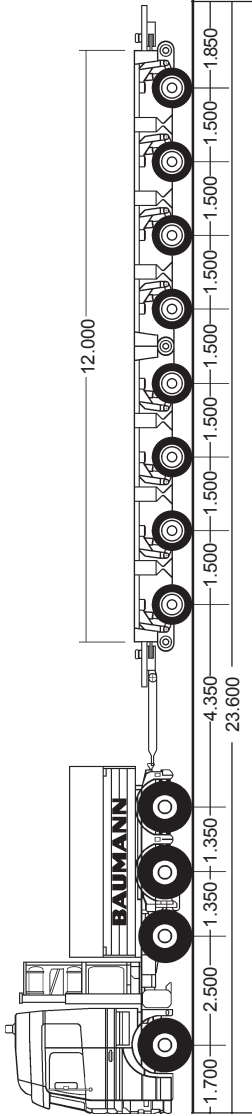
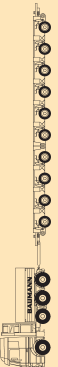
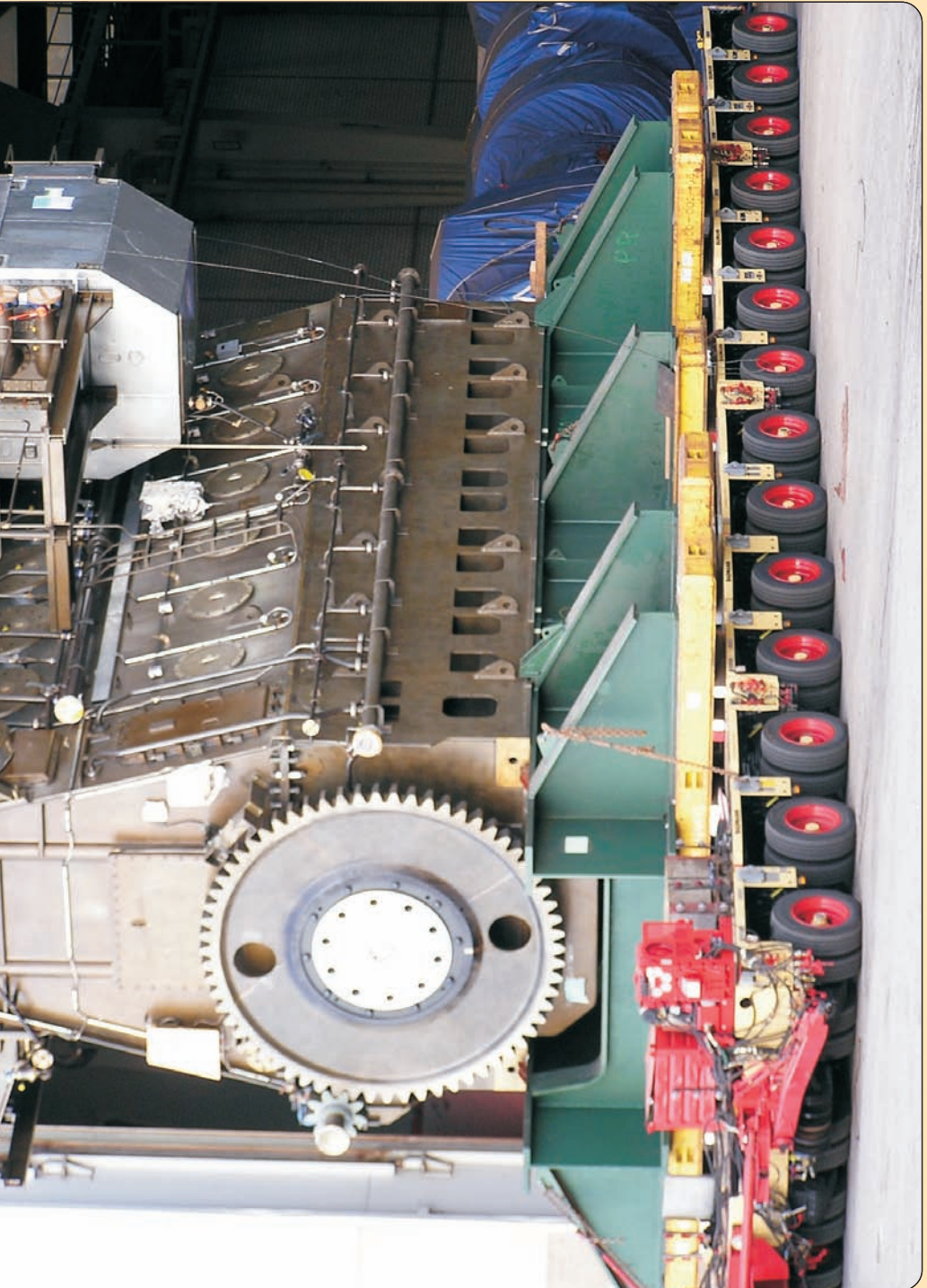
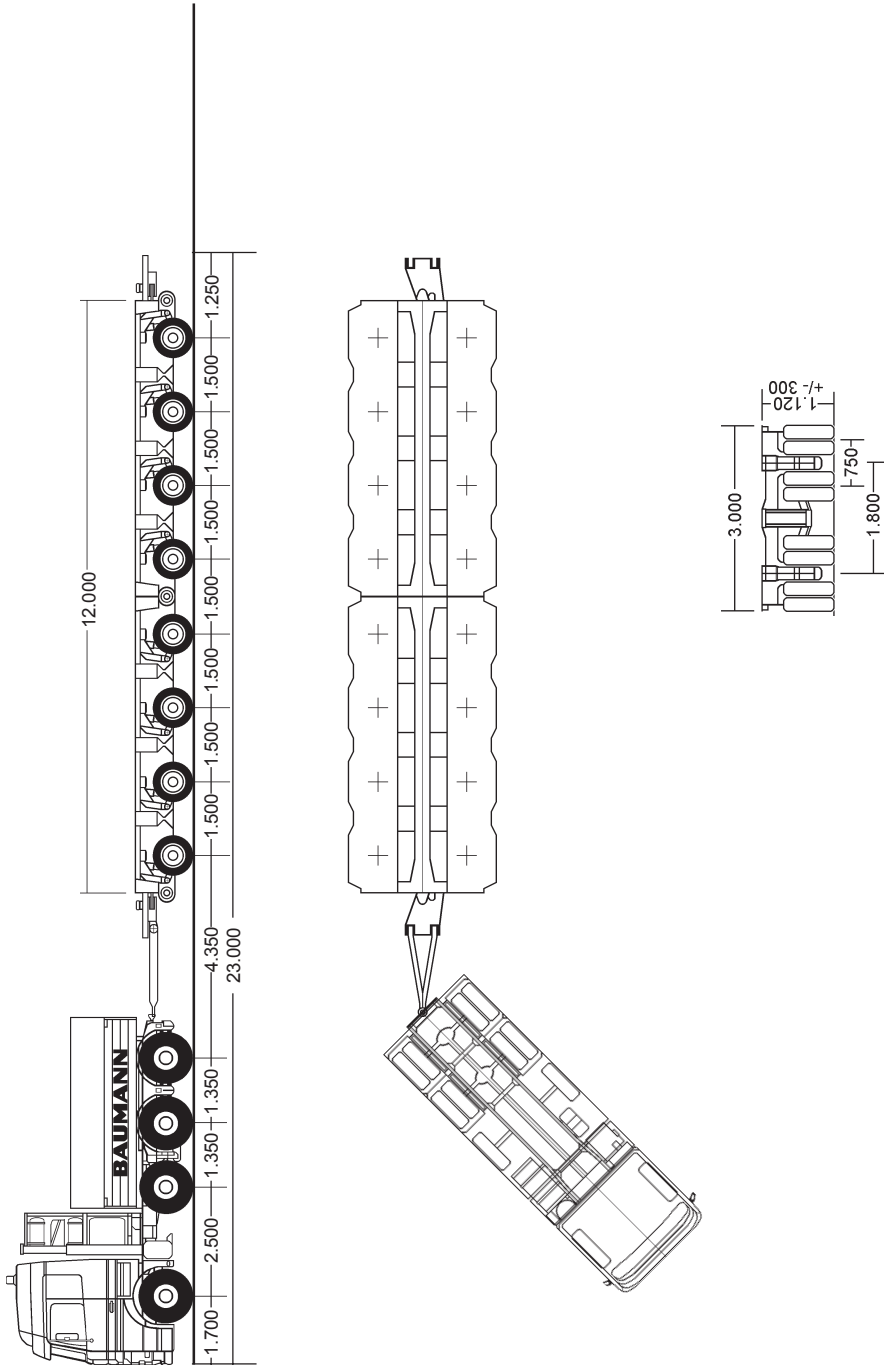

8-Achs Plateauanhänger
 techn. Nutzlast: 212.000 kg

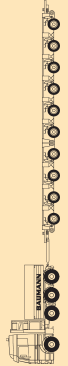

06-2007

Bornheim bei Bonn:
 02222 / 8303-0

www.Viktor-Baumann.de
 E-mail: Schwertransporte@Viktor-Baumann.de

Althen bei Leipzig:
 034291 / 436-0

8-Achs Plateauanhänger, Lastdiagramm
 techn. Nutzlast: 212.000 kg

